

## IMPORTANT SAFETY RULES

Read, understand, and follow all instructions carefully before installing and using this product.

# Deluxe Wall Mount Surface Skimmer

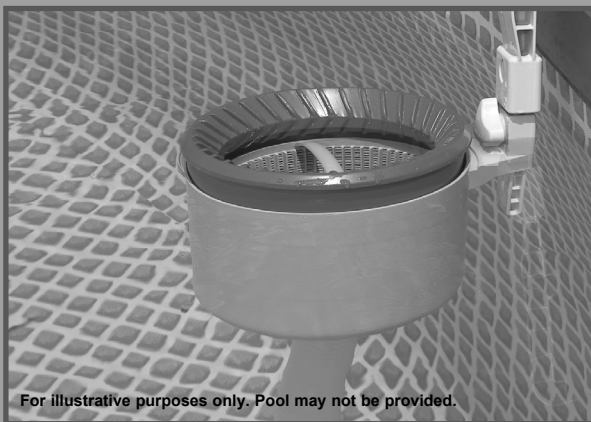

For illustrative purposes only. Pool may not be provided.

Don't forget to try these other fine Intex products: pools, pool accessories, inflatable pools and in-home toys, airbeds and boats available at fine retailers or visit our website.

Due to a policy of continuous product improvement, Intex reserves the right to change specifications and appearance, which may result in updates to the instruction manual without notice.

OWNER'S MANUAL

# INTEX®

©2020 Intex Marketing Ltd. - Intex Development Co. Ltd. - Intex Recreation Corp.

All rights reserved/Tous droits réservés/Todos los derechos reservados/Alle Rechte vorbehalten. Printed in China/Imprimé en Chine/Impreso en China/Gedruckt in China.

®™ Trademarks used in some countries of the world under license from/®™ Marques utilisées dans certains pays sous licence de/Marcas registradas utilizadas en algunos países del mundo bajo licencia de/Warenzeichen verwendet in einigen Ländern der Welt in Lizenz von/Intex Marketing Ltd. to/a/a/an Intex Development Co. Ltd., G.P.O. Box 28829, Hong Kong & Intex Recreation Corp., P.O. Box 1440, Long Beach, CA 90801 • Distributed in the European Union by/Distribué dans l'Union Européenne par/Distribuido en la unión Europea por/Vertrieb in der Europäischen Union durch/Intex Trading B.V., Venneveld 9, 4705 RR Roosendaal - The Netherlands  
[www.intexcorp.com](http://www.intexcorp.com)

122-\*A\*-R0-2106

## TABLE OF CONTENTS

<b>Warnings.....</b>	<b>3</b>
<b>Parts Reference.....</b>	<b>4</b>
<b>Hook Assembly for Easy-Set® Pools with Inflatable Top Rings.....</b>	<b>5</b>
<b>Hook Assembly for Metal Frame Pools &amp; Graphite gray panel™ pool.....</b>	<b>6</b>
<b>Setup Instructions.....</b>	<b>7-9</b>
<b>Long Term Storage.....</b>	<b>10</b>
<b>General Aquatic Safety.....</b>	<b>10</b>

**SAVE THESE INSTRUCTIONS**

# IMPORTANT SAFETY RULES

Read, Understand and Follow All Instructions Carefully Before Installing and Using this Product.

## WARNING

- Do not permit children to use this product. Adult use only.
- Do not operate the filter pump while the pool is occupied or in use.
- Strong suction. Do not remove or obstruct the floating cover opening while the filter pump is operating!
- Keep hands and hair away from the skimmer and floating cover opening when the filter pump is operating!
- Turn off or unplug the filter pump before adjusting, cleaning, servicing or removing the skimmer, basket or floating cover.
- Remove all maintenance items when the pool is in use.

**FAILURE TO FOLLOW THESE WARNINGS MAY RESULT IN PROPERTY DAMAGE, ELECTRIC SHOCK, SERIOUS INJURY, DROWNING OR DEATH.**

These product warnings, instructions and safety rules provided with the product represent some common risks of water recreation devices and do not cover all instances of risk and danger. Please use common sense and good judgement when enjoying any water activity.

**Filter Pump Flow Rate Requirement:**

1000 - 4000 gallons/hour (3785 - 15140 liters/hour)

# SAVE THESE INSTRUCTIONS

## PARTS REFERENCE

Before assembling your product, please take a few minutes to check the contents and become familiar with all the parts.

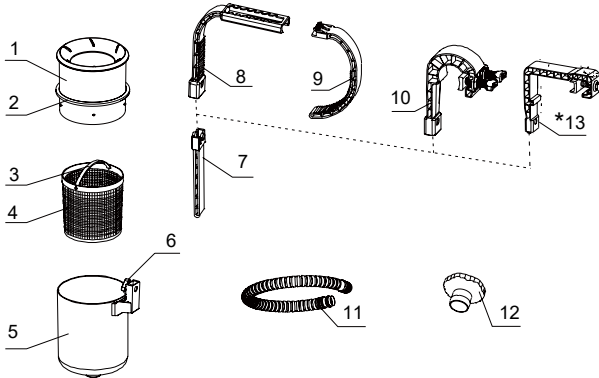

**NOTE:** Drawings for illustration purpose only. Actual product may vary. Not to scale.

EASY-SET® POOL	REF. NO.			DESCRIPTION	QTY.	SPARE PARTS NO.
	FRAME POOL	GRAPHITE GRAY PANEL™ POOL	COMMON			
			1	FLOATING COVER	1	11075A
			2	COVER RIM	1	11076
			3	BASKET HANDLE	1	11077
			4	BASKET (BASKET HANDLE INCLUDED)	1	11078
			5	SKIMMER	1	11079
			6	SCREW	1	10526
			7	DEPTH ADJUSTER	1	10522
8				HOOK (OPTIONAL)	1	10521
9				ARM (OPTIONAL)	1	10520
	10			FRAME HOOK (OPTIONAL)	1	11502
			11	SKIMMER HOSE	1	10531
			12	HOSE ADAPTOR B	1	11238A
		*13		TOP BOARD HOOK (OPTIONAL)	1	11153

\*Note: This part is only included in the package if the product was purchased as part of a Graphite Gray Panel™ Pool Set. Not included if the product was purchased individually without a Pool Set, contact the Authorized Service Centers to order the part if needed.

# SAVE THESE INSTRUCTIONS

Page 4

## HOOK ASSEMBLY FOR EASY SET® POOLS WITH INFLATABLE TOP RINGS

1

**NOTE:** If you are using a METAL FRAME POOL, go to page 6.

Connect the skimmer hose (11) to the skimmer (5) bottom connector.

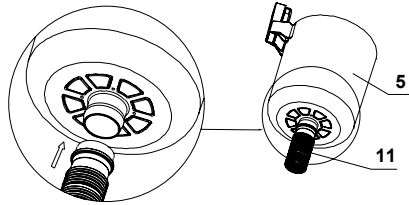

2

Assemble the hook as shown. Adjust the opening of the hook (8) by pressing and sliding the arm (9) at the same time.

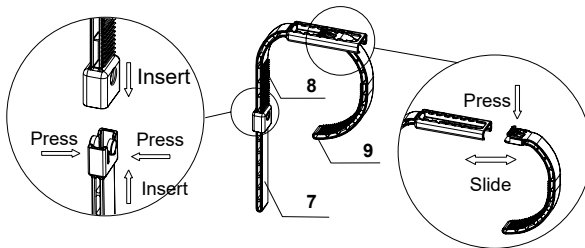

3

Loosen the skimmer screw (6), attach the assembled hook and hand tighten the screw. **NOTE:** Do not over tighten or use tools such as pliers.

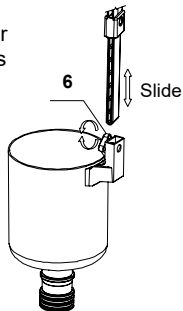

4

Place the whole assembled hook unit over the top of an EASY-SET® Pool Top Ring near the water outlet connector (lower hose connection). Adjust the hook to be snug around the inflated ring (see step #2). Ensure the hook is securely tightened over the pool.

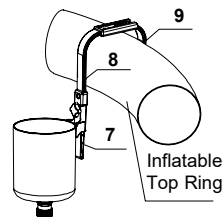

# SAVE THESE INSTRUCTIONS

## HOOK ASSEMBLY FOR METAL FRAME POOLS AND GRAPHITE GRAY PANEL™ POOL

1

Connect the skimmer hose (11) to the skimmer (5) bottom connector.

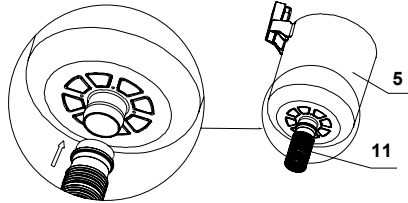

2

Assemble the hook as shown.

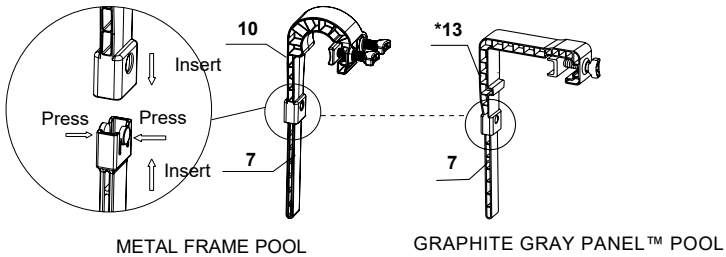

3

Loosen the skimmer screw (6), attach the assembled hook and hand tighten the screw.  
NOTE: Do not over tighten or use tools such as pliers.

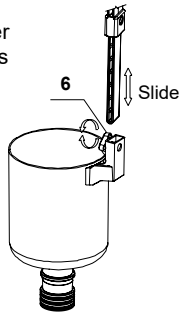

4

Place the whole assembled hook unit over the top of a FRAME Pool Top Beam near the water outlet connector (lower hose connection). Adjust the hook by adjusting the two dove-tail screws, to be tight on the top beam. Ensure the hook is securely tightened over the pool top beam.

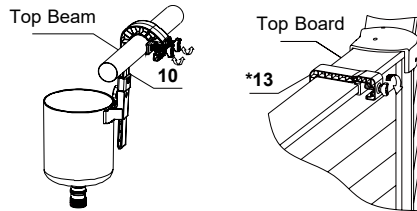

# SAVE THESE INSTRUCTIONS

## SETUP INSTRUCTIONS

1

For pool size 16' (488 cm) and below:  
Unscrew the strainer grid from the threaded strainer connector (lower) from inside of the pool.

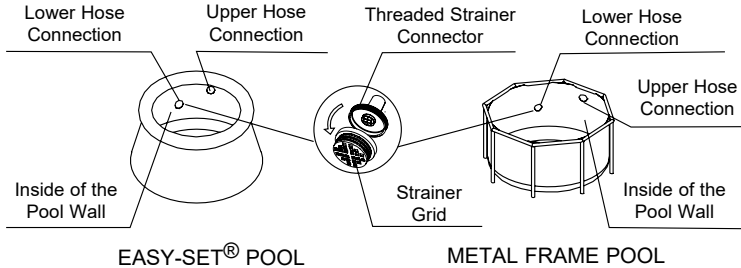

2

Depending on the size of pool purchased.

For 16' (488 cm) and below pools with Strainer

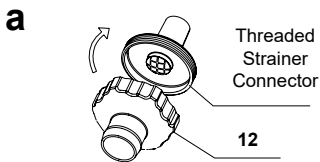

Screw the hose adaptor B (12) to the threaded strainer connector, from inside of the pool.

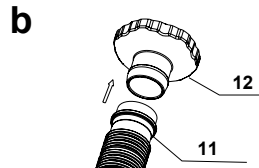

Connect the other end of the skimmer hose (11) to the hose adaptor B (12).

For 18' (549 cm) and above pools with Large Strainer

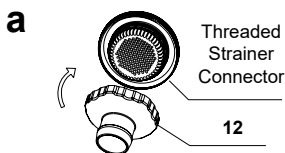

Screw the hose adaptor B (12) to the threaded strainer connector, from inside of the pool.

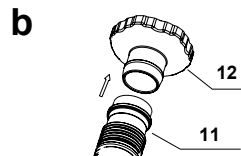

Connect the other end of the skimmer hose (11) to the hose adaptor B (12).

# SAVE THESE INSTRUCTIONS

## SETUP INSTRUCTIONS (continued)

3

Place the basket (4), cover rim (2) and the floating cover (1) into the skimmer (5). **NOTE:** The cover rim must be installed in place in order to hold the floating cover in position.

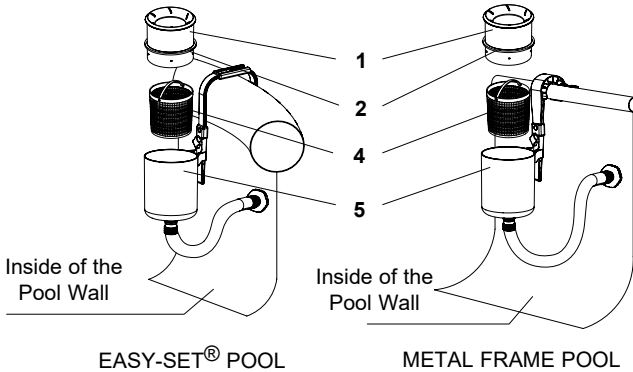

4

The floating cover (1) should be floating off the skimmer (5) by 1" to 5" (2.5cm to 12.7cm). Loosen the skimmer screw, slide the skimmer up and down on the assembled hook to adjust the height. Hand tight the screw when done.

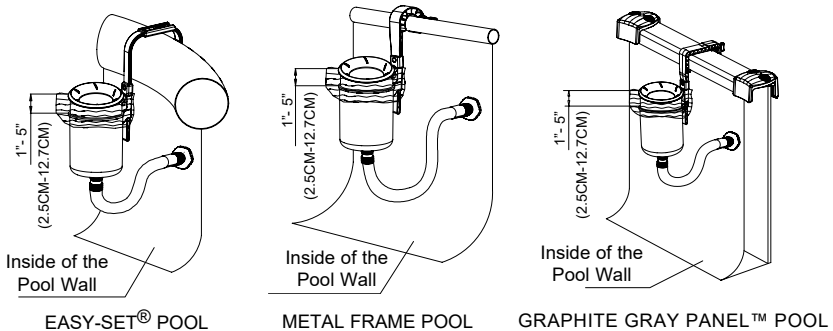

**IMPORTANT:** The skimmer must stay vertical at all times, so that the top of the floating cover can parallel to the water surface for skimming.

# SAVE THESE INSTRUCTIONS



## SETUP INSTRUCTIONS (continued)

5

### WARNING

- Do not operate the filter pump while the pool is occupied or in use.
  - Strong suction. Do not remove or obstruct the floating cover opening while the filter pump is operating!
  - Keep hands and hair away from the skimmer and floating cover opening when the filter pump is operating!
  - Turn off or unplug the filter pump before adjusting, cleaning, servicing or removing the skimmer, basket or floating cover.
- 
- Set up the filter pump following the filter pump owner's manual. Turn on or connect the filter pump to an electrical outlet.

### IMPORTANT

If no water is flowing into the pump, make sure that the surface skimmer is perpendicular to the water surface and below the water surface. Open the air release valve located on the filter housing top cover. When water starts to flow out, close the air release valve back.

**Never run the pump dry as the motor may overheat and damage the pump!**

- Remove the skimmer and the hook assembly from the pool before placing a pool cover over the pool.
- Store the product and accessories in a dry and safe place indoors.

**NOTE:** On a weekly basis, remove the hose adaptor from the outlet fitting connection to ensure the threaded strainer connector is free from debris, hair and algae. Also make sure the cartridge in the filter pump is clean and there is no leakage in the circulation system.

# SAVE THESE INSTRUCTIONS

## LONG TERM STORAGE

1. Make sure the filter pump is turned off and disconnect the power cord from the electrical outlet.
2. Using the Set-Up instructions in reverse, disassemble the floating surface skimmer.
3. Clean and air dry all the accessories and parts thoroughly.
4. The original packaging can be used for storage. Store in a dry, cool storage location.

## GENERAL AQUATIC SAFETY

**Water recreation is both fun and therapeutic. However, it involves inherent risks of injury and death. To reduce your risk of injury, read and follow all product, package and package insert warnings and instructions. Remember, however, that product warnings, instructions and safety guidelines cover some common risks of water recreation, but do not cover all risks and or dangers.**

**For additional safeguards, also familiarize yourself with the following general guidelines as well as guidelines provided by nationally recognized Safety Organizations:**

- Demand constant supervision. A competent adult should be appointed as a "lifeguard" or water watcher, especially when children are in and around the pool.
- Learn to swim.
- Take the time to learn CPR and first aid.
- Instruct anyone who is supervising pool users about potential pool hazards and about the use of protective devices such as locked doors, barriers, etc.
- Instruct all pool users, including children what to do in case of an emergency.
- Always use common sense and good judgement when enjoying any water activity.
- Supervise, supervise, supervise.

# SAVE THESE INSTRUCTIONS